

FEATURES

- ❑ Dual 8-Deep Pipeline Register
- ❑ Configurable to Single 16-Deep
- ❑ Low Power CMOS Technology
- ❑ Replaces AMD Am29525
- ❑ Load, Shift, and Hold Instructions
- ❑ Separate Data In and Data Out Pins
- ❑ Three-State Outputs
- ❑ Package Styles Available:
 - 28-pin Plastic DIP
 - 28-pin Plastic LCC, J-Lead

DESCRIPTION

The **L29C525** is a high-speed, low power CMOS pipeline register. It is pin-for-pin compatible with the AMD Am29525. The L29C525 can be configured as two independent 8-level pipelines or as a single 16-level pipeline. The configuration implemented is determined by the instruction code (I1-0) as shown in Table 2.

The I1-0 instruction code controls the internal routing of data and loading of each register. For instruction I1-0 = 00 (Push A and B), data applied at the D7-0 inputs is latched into register A0 on the rising edge of CLK. The contents of A0 simultaneously move to register A1, A1 moves to A2, and so on. The contents of register A7 are wrapped back to register B0. The registers on the B side are similarly shifted, with the contents of register B7 lost.

Instruction I1-0 = 01 (Push B) acts similarly to the Push A and B instruction, except that only the B side registers are shifted. The input data is applied to register B0, and the contents of register B7 are lost. The contents of the A side registers are unaffected. Instruction I1-0 = 10 (Push A) is identical to the Push B instruction, except that the A side registers are shifted and the B side registers are unaffected.

Instruction I1-0 = 11 (Hold) causes no internal data movement. It is equivalent to preventing the application of a clock edge to any internal register.

The contents of any of the registers is selectable at the output through the use of the S3-0 control inputs. The independence of the I and S control lines allows simultaneous reading and writing. Encoding for the S3-0 controls is given in Table 3.

L29C525 BLOCK DIAGRAM

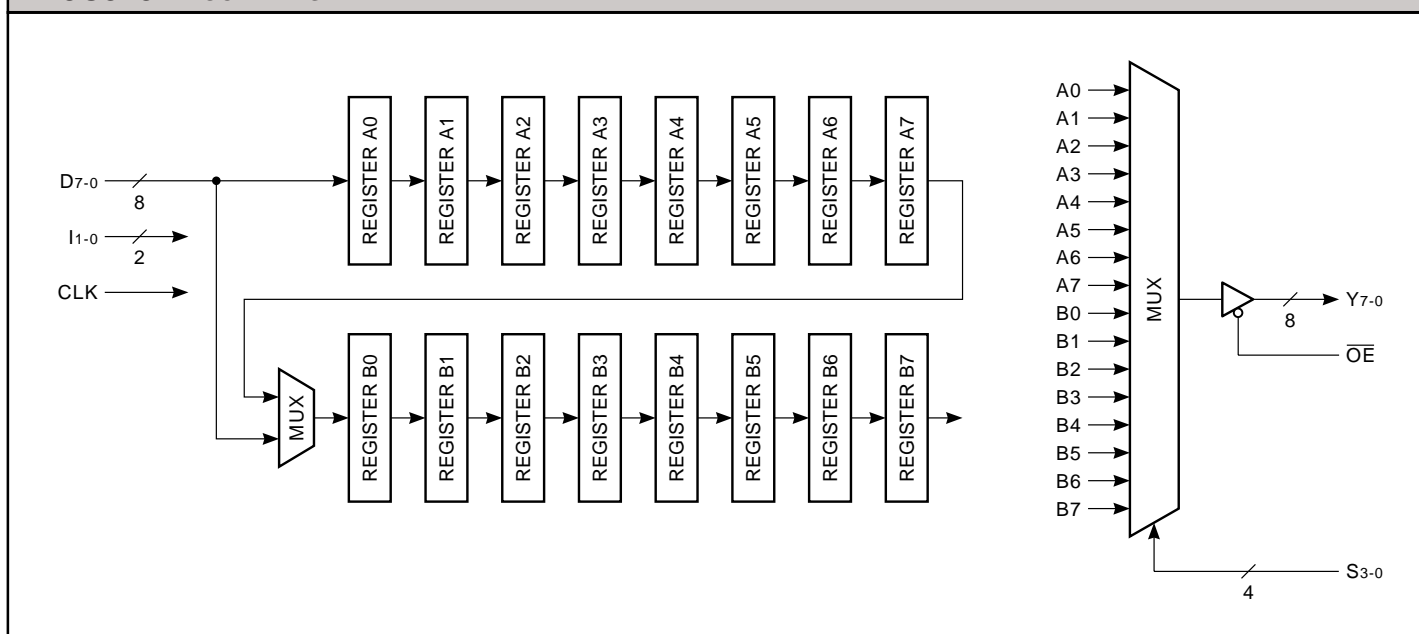

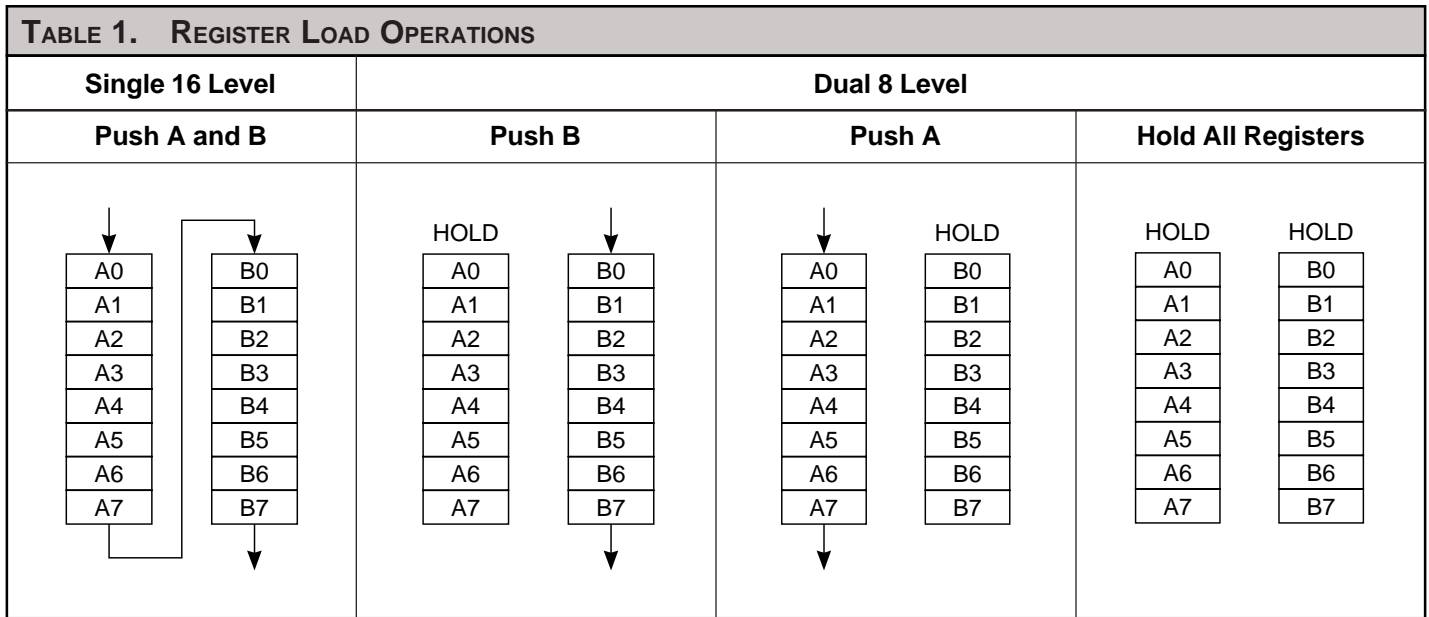

TABLE 2. INSTRUCTION SET

Mnemonics	Inputs		Description
	I1	I0	
Shift	0	0	Push A and B
LDB	0	1	Push B
LDA	1	0	Push A
HLD	1	1	Hold All Registers

TABLE 3. OUTPUT SELECT

S3	S2	S1	S0	Y7-0
0	0	0	0	A0
0	0	0	1	A1
0	0	1	0	A2
0	0	1	1	A3
0	1	0	0	A4
0	1	0	1	A5
0	1	1	0	A6
0	1	1	1	A7
1	0	0	0	B0
1	0	0	1	B1
1	0	1	0	B2
1	0	1	1	B3
1	1	0	0	B4
1	1	0	1	B5
1	1	1	0	B6
1	1	1	1	B7

Dual Pipeline Register

MAXIMUM RATINGS <i>Above which useful life may be impaired (Notes 1, 2, 3, 8)</i>	
Storage temperature	-65°C to +150°C
Operating ambient temperature	-55°C to +125°C
V _{CC} supply voltage with respect to ground	-0.5 V to +7.0 V
Input signal with respect to ground	-3.0 V to +7.0 V
Signal applied to high impedance output	-3.0 V to +7.0 V
Output current into low outputs	25 mA
Latchup current	> 400 mA

OPERATING CONDITIONS <i>To meet specified electrical and switching characteristics</i>		
Mode	Temperature Range (Ambient)	Supply Voltage
Active Operation, Commercial	0°C to +70°C	4.75 V ≤ V _{CC} ≤ 5.25 V
Active Operation, Military	-55°C to +125°C	4.50 V ≤ V _{CC} ≤ 5.50 V

ELECTRICAL CHARACTERISTICS <i>Over Operating Conditions (Note 4)</i>						
Symbol	Parameter	Test Condition	Min	Typ	Max	Unit
V _{OH}	Output High Voltage	V _{CC} = Min., I _{OH} = -12 mA	2.4			V
V _{OL}	Output Low Voltage	V _{CC} = Min., I _{OL} = 24 mA			0.5	V
V _{IH}	Input High Voltage		2.0		V _{CC}	V
V _{IL}	Input Low Voltage	(Note 3)	0.0		0.8	V
I _{Ix}	Input Current	Ground ≤ V _{IN} ≤ V _{CC} (Note 12)			±20	μA
I _{OZ}	Output Leakage Current	Ground ≤ V _{OUT} ≤ V _{CC} (Note 12)			±20	μA
I _{CC1}	V _{CC} Current, Dynamic	(Notes 5, 6)		10	35	mA
I _{CC2}	V _{CC} Current, Quiescent	(Note 7)			1.0	mA

SWITCHING CHARACTERISTICS

COMMERCIAL OPERATING RANGE (0°C to +70°C) Notes 9, 10 (ns)					
Symbol	Parameter	L29C525-			
		20		15	
		Min	Max	Min	Max
t _{PD}	Clock to Output Delay		20		15
t _{SEL}	Select to Output Delay		20		15
t _{PW}	Clock Pulse Width	12		10	
t _{SD}	Data Setup Time	7		5	
t _{HD}	Data Hold Time	0		0	
t _{SI}	Instruction Setup Time	7		5	
t _{HI}	Instruction Hold Time	2		2	
t _{ENA}	Three-State Output Enable Delay (Note 11)		15		15
t _{DIS}	Three-State Output Disable Delay (Note 11)		13		13

MILITARY OPERATING RANGE (-55°C to +125°C) Notes 9, 10 (ns)					
Symbol	Parameter	L29C525-			
		25*		20*	
		Min	Max	Min	Max
t _{PD}	Clock to Output Delay		25		20
t _{SEL}	Select to Output Delay		25		20
t _{PW}	Clock Pulse Width	12		12	
t _{SD}	Data Setup Time	7		7	
t _{HD}	Data Hold Time	2		2	
t _{SI}	Instruction Setup Time	7		7	
t _{HI}	Instruction Hold Time	2		2	
t _{ENA}	Three-State Output Enable Delay (Note 11)		15		15
t _{DIS}	Three-State Output Disable Delay (Note 11)		13		13

SWITCHING WAVEFORMS

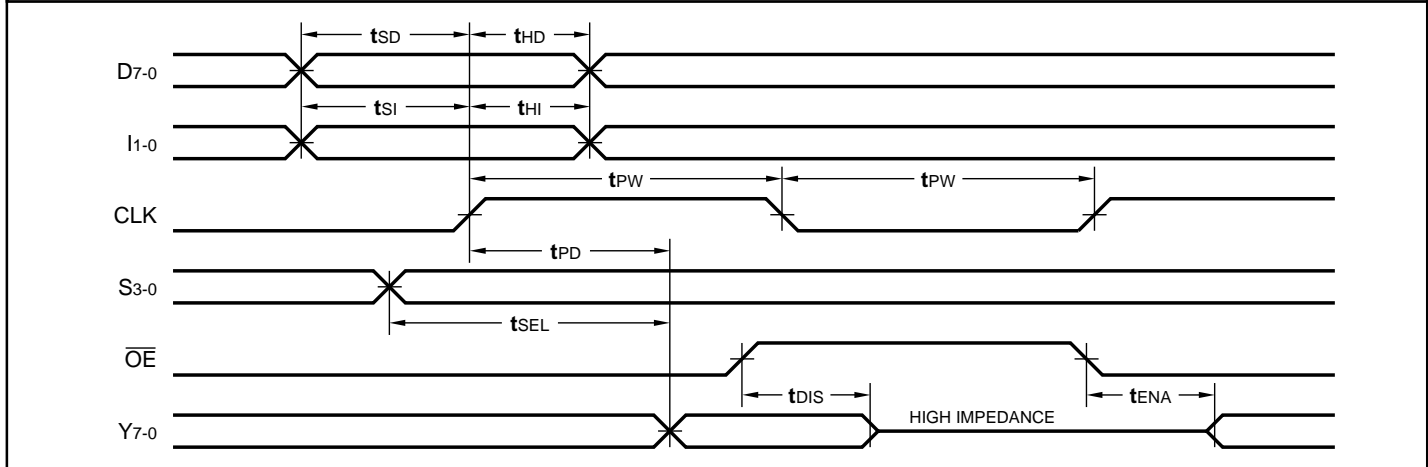

*DISCONTINUED SPEED GRADE

NOTES

1. Maximum Ratings indicate stress specifications only. Functional operation of these products at values beyond those indicated in the Operating Conditions table is not implied. Exposure to maximum rating conditions for extended periods may affect reliability.

2. The products described by this specification include internal circuitry designed to protect the chip from damaging substrate injection currents and accumulations of static charge. Nevertheless, conventional precautions should be observed during storage, handling, and use of these circuits in order to avoid exposure to excessive electrical stress values.

3. This device provides hard clamping of transient undershoot and overshoot. Input levels below ground or above VCC will be clamped beginning at -0.6 V and VCC + 0.6 V. The device can withstand indefinite operation with inputs in the range of -0.5 V to +7.0 V. Device operation will not be adversely affected, however, input current levels will be well in excess of 100 mA.

4. Actual test conditions may vary from those designated but operation is guaranteed as specified.

5. Supply current for a given application can be accurately approximated by:

$$\frac{NCV^2F}{4}$$

where

4

- N = total number of device outputs
- C = capacitive load per output
- V = supply voltage
- F = clock frequency

6. Tested with all outputs changing every cycle and no load, at a 5 MHz clock rate.

7. Tested with all inputs within 0.1 V of VCC or Ground, no load.

8. These parameters are guaranteed but not 100% tested.

9. AC specifications are tested with input transition times less than 3 ns, output reference levels of 1.5 V (except tDIS test), and input levels of nominally 0 to 3.0 V. Output loading may be a resistive divider which provides for specified IOH and IOL at an output voltage of VOH min and VOL max respectively. Alternatively, a diode bridge with upper and lower current sources of IOH and IOL respectively, and a balancing voltage of 1.5 V may be used. Parasitic capacitance is 30 pF minimum, and may be distributed.

This device has high-speed outputs capable of large instantaneous current pulses and fast turn-on/turn-off times. As a result, care must be exercised in the testing of this device. The following measures are recommended:

- a. A 0.1 μF ceramic capacitor should be installed between VCC and Ground leads as close to the Device Under Test (DUT) as possible. Similar capacitors should be installed between device VCC and the tester common, and device ground and tester common.
- b. Ground and VCC supply planes must be brought directly to the DUT socket or contactor fingers.
- c. Input voltages should be adjusted to compensate for inductive ground and VCC noise to maintain required DUT input levels relative to the DUT ground pin.

10. Each parameter is shown as a minimum or maximum value. Input requirements are specified from the point of view of the external system driving the chip. Setup time, for example, is specified as a minimum since the external system must supply at least that much time to meet the worst-case requirements of all parts. Responses from the internal circuitry are specified from the point of view of the device. Output delay, for example, is specified as a maximum since worst-case operation of any device always provides data within that time.

11. For the tENA test, the transition is measured to the 1.5 V crossing point with datasheet loads. For the tDIS test, the transition is measured to the ±200mV level from the measured steady-state output voltage with ±10mA loads. The balancing voltage, VTH, is set at 3.5 V for Z-to-0 and 0-to-Z tests, and set at 0 V for Z-to-1 and 1-to-Z tests.

12. These parameters are only tested at the high temperature extreme, which is the worst case for leakage current.

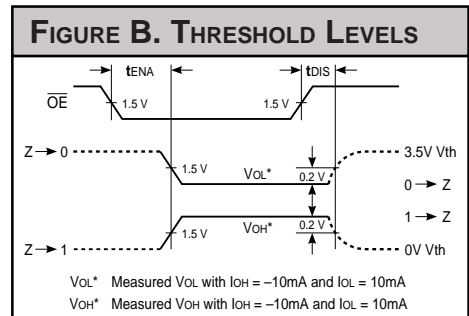
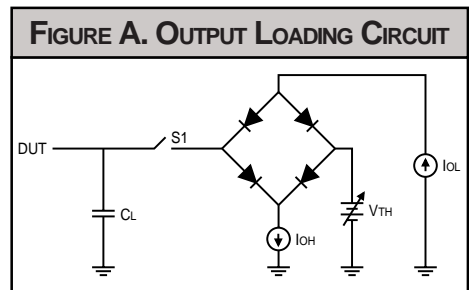

ORDERING INFORMATION

28-pin — 0.3" wide

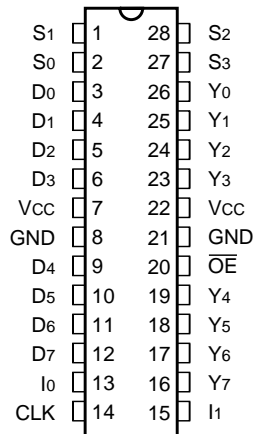

28-pin

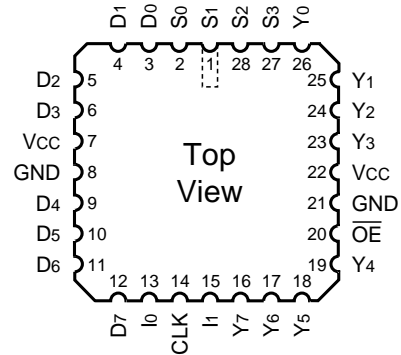

Speed	Plastic DIP (P10)	Plastic J-Lead Chip Carrier (J4)
	0°C to +70°C — COMMERCIAL SCREENING	0°C to +70°C — COMMERCIAL SCREENING
20 ns	L29C525PC20	L29C525JC20
15 ns	L29C525PC15	L29C525JC15
	-55°C to +125°C — COMMERCIAL SCREENING	-55°C to +125°C — COMMERCIAL SCREENING
	-55°C to +125°C — MIL-STD-883 COMPLIANT	-55°C to +125°C — MIL-STD-883 COMPLIANT